

Pressure sensor with IO-Link PNP or NPN switching output Model A-1200

WIKA data sheet PE 81.90



Applications

- Machine tools
- Hydraulics and pneumatics
- Automation engineering
- Special-purpose machine building

Special features

- Industry 4.0-ready IO-Link sensor improves connectivity and diagnostics
- Designed for rough demands of up to 1,000 g shock and -40 ... +125 °C [-40 ... +257 °F]
- Optimised design makes OEM machine integration easier
- Multicolour 360° LED status display simplifies troubleshooting and localisation



Fig. left: Metal version

Fig. right: Version with three-coloured status display

Description

The model A-1200 is a pressure sensor without display that can be flexibly programmed via IO-Link and used in a variety of ways – whether for pressure monitoring or as an electronic PNP/NPN switch for process control.

More safety through digital connectivity

Thanks to IO-Link, the model A-1200 pressure sensor is ideal for use in intelligent machines. To ensure precise measurement results over the long term, the pressure sensor has integrated diagnostic functions that monitor the instrument status. In addition, the model A-1200 can be configured externally and conveniently via the digital signal and adjusted at any time.

Robust and durable, even in harsh environments

The robust version of the model A-1200 has been designed specifically for extreme environmental conditions. With a welded M12 x 1 connector, this can easily withstand shock loads of up to 1,000 g. It is designed for medium

temperatures between -40 ... +125 °C and can therefore be integrated into almost any application. Downtime and associated maintenance expenses and costs decrease significantly due to the stable design.

Simple OEM integration

The integration of the model A-1200 pressure sensor into OEM series production is accomplished quickly. The sensors can be preset by WIKA based on the customer's desired parameters. Alternatively, automated IO-Link programming can shorten the configuration time in the factory.

Fast maintenance thanks to visual feedback

A 360° LED status display provides visual information about the sensor status. The green (OK), yellow (critical state) or red (error) signal enables intuitive and fast error detection and correction. For maintenance, a blinking function via IO-Link facilitates the clear localisation of a pressure sensor. Confusion is prevented and maintenance is accelerated.

Measuring ranges

Gauge pressure								
bar	0 ... 0.4	0 ... 0.6	0 ... 1	0 ... 1.6	0 ... 2.5	0 ... 4	0 ... 6	0 ... 10
	0 ... 16	0 ... 25	0 ... 40	0 ... 60	0 ... 100	0 ... 160	0 ... 250	0 ... 400
	0 ... 600	0 ... 1,000						
psi	0 ... 10	0 ... 15	0 ... 25	0 ... 30	0 ... 50	0 ... 100	0 ... 160	0 ... 200
	0 ... 300	0 ... 500	0 ... 1,000	0 ... 1,500	0 ... 2,000	0 ... 3,000	0 ... 5,000	0 ... 7,500
	0 ... 10,000	0 ... 15,000						

Absolute pressure								
bar	0 ... 0.4	0 ... 0.6	0 ... 1	0 ... 1.6	0 ... 2.5	0 ... 4	0 ... 6	0 ... 10
	0 ... 16	0 ... 25						
psi	0 ... 10	0 ... 15	0 ... 25	0 ... 30	0 ... 50	0 ... 100	0 ... 160	0 ... 200
	0 ... 300							

Vacuum and +/- measuring range								
bar	-1 ... 0	-1 ... +0.6	-1 ... +1.5	-1 ... +3	-1 ... +5	-1 ... +9	-1 ... +15	-1 ... +24
psi	-14.5 ... 0	-14.5 ... +15	-14.5 ... +30	-14.5 ... +50	-14.5 ... +100	-14.5 ... +160	-14.5 ... +200	-14.5 ... +300

The given measuring ranges are also available in kg/cm², kPa and MPa.

Special measuring ranges between 0 ... 0.4 and 0 ... 1,000 bar [0 ... 10 to 0 ... 15,000 psi] are available on request.

Special measuring ranges have a reduced long-term stability and higher temperature errors.

Overload safety

The overload safety is based on the sensor element used. Dependent on the selected process connection and the sealing, restrictions in overload safety can result.

- Measuring range ≤ 600 bar [< 8,000 psi]: 2 times
- Measuring range > 1,000 bar [≥ 8,000 psi]: 1.5 times

Increased overload safety (option)

With increased overload safety there are deviations in temperature error and long-term stability.

Vacuum-tight

Yes

LED status display (option)

Visibility: 360°
 Green: Operation
 Yellow: Warning
 Red: Error

Output signals

Switching output		IO-Link 1.1	Teach
SP1	SP2		
PNP	-	-	-
PNP	-	x	-
NPN	-	-	-
PNP	-	-	x
NPN	-	-	x
PNP	PNP	x	-
NPN	NPN	-	-

IO-Link

Revision: 1.1
 Transmission rate: 38.4 kBaud (COM2)
 Min. cycle time: 2.3 ms
 Master port class: A

Adjustment of zero point offset

max. 3 % of span (via IO-Link)

Damping of switching outputs

0 ms ... 65 s (adjustable via IO-Link)

Switch-on time

1 s

Switching thresholds

Switch point 1 and switch point 2 are individually adjustable via IO-Link.

Switch point 1 can be set to the prevailing pressure value using the teach function.

Switching functions

Normally open, normally closed, window, hysteresis (adjustable via IO-Link)

The switching function of switch point 1 can be set to normally closed or normally open using the teach function.

Switching voltage

Power supply - 1 V

Switching current

max. 250 mA, see derating curves

Response time of switching output

≤ 5 ms

Service life

100 million switching cycles

Derating curve per switching output, without UL approval

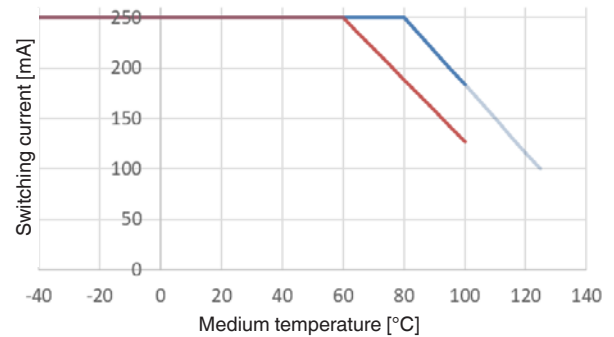

— Standard
 — Without IO-Link, Teach or LED indicator
 — With M12 x 1 circular connector, metallic

Derating curve per switching output, with UL approval

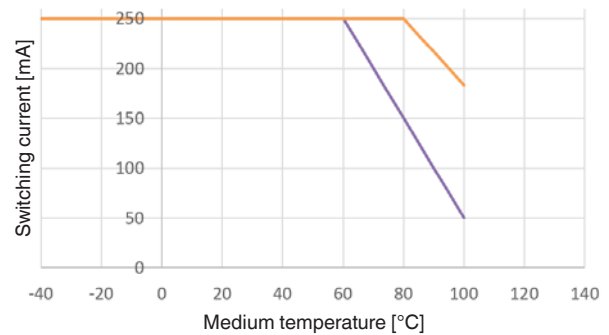

— Standard and IO-Link, Teach or LED indicator
 — With M12 x 1 circular connector, metallic

Voltage supply

Power supply

DC 10 ... 32 V

Current consumption

≤ 25 mA

Total current consumption

≤ 0.3 A incl. switching current (with one switching output)
≤ 0.6 A incl. switching current (with two switching outputs)

Reference conditions (per IEC 61298-1)

Temperature: 15 ... 25 °C [59 ... 77 °F]
Atmospheric pressure: 860 ... 1,060 mbar [12.5 ... 15.4 psi]
Air humidity: 45 ... 75 % r. h.
Nominal position: Calibrated in vertical mounting position with process connection facing downwards.
Power supply: DC 24 V

Accuracy specifications

Accuracy, switching output

≤ ±1 % of span (option: ≤ ±0.5 % of span)

Long-term drift, switching output

≤ ±0.1 %
≤ ±0.2 % for measuring ranges ≤ 0.69 bar [10 psi]
≤ ±0.26 % for increased overload safety

Switching current dependency

With switching currents greater than 50 mA:
≤ ±0.05 % per 50 mA additional applied switching current

Versions without teach function, LED status display and IO-Link 1.1:

≤ ±0.075 % per 50 mA additional applied switching current

Temperature error in rated temperature range

≤ ±1.5 % of span
≤ ±2.5 % of span for increased overload safety

Temperature coefficients in rated temperature range

Mean TC zero point: ≤ ±0.16 % of span/10 K
Mean TC span: ≤ ±0.16 % of span/10 K

Operating conditions

Permissible temperature ranges

	Standard	Option 1) 2)
Medium	-30 ... +100 °C [-22 ... +212 °F]	-40 ... +125 °C [-40 ... +257 °F]
Ambient	-30 ... +85 °C [-22 ... +185 °F]	-40 ... +85 °C [-40 ... +185 °F]
Storage	-40 ... +70 °C [-40 ... +158 °F]	
Nominal temperature	-20 ... +80 °C [-4 ... +176 °F]	

1) Only for circular connector M12 x 1, metal

2) Medium temperature limited to -40 ... +100 °C [-40 ... +212 °F] with UL approval

Humidity

45 ... 75 % r. h.

Vibration resistance

25 g, 10 ... 2,000 Hz (IEC 60068-2-6, under resonance)

Shock resistance

100 g, 6 ms (IEC 60068-2-27, mechanical)
1,000 g, 1 ms (IEC 60068-2-27, mechanical) ¹⁾

1) Only for electrical connection, M12 x 1 metal

Service life

100 million load cycles

Ingress protection (per IEC 60529)

see "Electrical connections"

Mounting position

as required

Materials

Wetted parts

Measuring ranges < 10 bar [150 psi]: 316L
Measuring ranges ≥ 10 bar [150 psi]: 316L, PH grade steel

Non-wetted parts

Case: 316L
Circular connector M12 x 1, metal: 316L
Circular connector M12 x 1: PBT GF30
LED status display: PC

Pressure transmission medium

Synthetic oil for all gauge pressure measuring ranges < 10 bar [150 psi] ¹⁾ and all absolute pressure measuring ranges.

¹⁾ < 16 bar [250 psi] with increased overload safety

Options for specific media

- Oil and grease free: Residual hydrocarbon: < 1,000 mg/m²
 - Oxygen, oil and grease free: Residual hydrocarbon: < 200 mg/m²
- Packaging: Protection cap on the process connection, instrument sealed in a vacuum bag
Max. permissible temperature -20 ... +60 °C [-4 ... +140 °F]
Available measuring ranges:
0 ... 0.4 bar to 0 ... 400 bar [0 ... 10 to 0 ... 5,000 psi]
-1 ... 0 to -1 ... 24 bar [-14.5 ... 0 to -14.5 ... 300 psi]
Factory supplied without sealing
Available process connections, see "Process connections"

Process connections

Standard	Thread	Max. nominal pressure	Sealing
DIN EN ISO 1179-2 (formerly DIN 3852-E)	G ¼ A	600 bar [8,700 psi]	NBR (options: Without, FPM/FKM)
	G ½ A	400 bar [5,800 psi]	NBR (options: Without, FPM/FKM)
EN 837	G ¼ B ¹⁾	1,000 bar (14,500 psi)	without (options: Copper, stainless steel)
	G ¼ female ¹⁾	1,000 bar (14,500 psi)	without (options: Copper, stainless steel)
	G ½ B ¹⁾	1,000 bar (14,500 psi)	without (options: Copper, stainless steel)
ANSI/ASME B1.20.1	¼ NPT 1)	1,000 bar (14,500 psi)	-
	½ NPT 1)	1,000 bar (14,500 psi)	-
ISO 7	R ¼ 1)	1,000 bar (14,500 psi)	-
KS	PT ¼ 1)	1,000 bar (14,500 psi)	-
-	G ¼ female (Ermeto compatible)	1,000 bar (14,500 psi)	without (options: Copper, stainless steel)

¹⁾ suitable for oxygen, oil and grease free.

Other connections on request.

Restrictor (option)

For applications where pressure spikes can occur, the use of a restrictor is recommended. The restrictor narrows the pressure port to 0.6 mm and thus increases the resistance against pressure spikes.

Enlarged pressure port (option)

For applications with contaminated or viscous media, for specific process connections, an enlarged pressure port with a 6 or 12 mm diameter is available in order to reduce the risk of a pressure port blocking.

Electrical connections

Connection	Ingress protection (per IEC 60529)
Circular connector M12 x 1, metal (4-pin)	IP65 and IP67
Circular connector M12 x 1 (4-pin)	
with LED status display	IP65 and IP67
without LED status display	IP65 and IP67
Angular connector DIN 175301-803 A (3-pin) ¹⁾	
with LED status display	IP65
without LED status display	IP65

1) Only available without IO-Link and without teach function

The stated ingress protection (per IEC 60529) only applies when plugged in using mating connectors that have the appropriate ingress protection.

Electrical safety

Short-circuit resistance: SP1 / SP2 vs. U-

Reverse polarity protection: U+ vs. U-

Insulation voltage: DC 500 V

Overvoltage protection: DC 36 V

Connection diagram

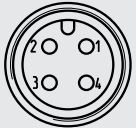
Circular connector M12 x 1 (4-pin)	
	U+ 1
	U- 3
	SP1 / C 4
	SP2 / Teach 2

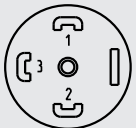
Angular connector DIN 175301-803 A (3-pin)	
	U+ 1
	U- 2
	SP1 3

Legend:

U+ Positive power supply terminal

U- Negative power supply terminal

SP1 Switching output 1

SP2 Switching output 2

C Communication with IO-Link

Teach Teach input for switching output/switching function

Dimensions in mm [in]

Circular connector M12 x 1 with LED status display

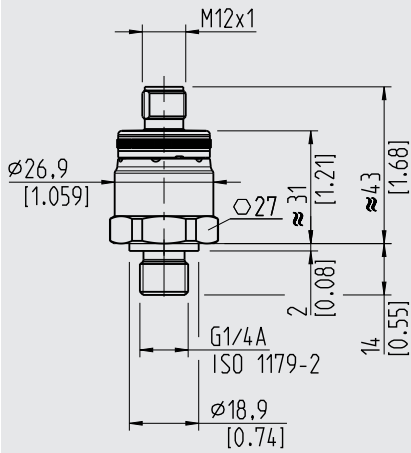

Weight: 60 ... 100 g [2.12 ... 3.53 oz]

Circular connector M12 x 1, metallic version

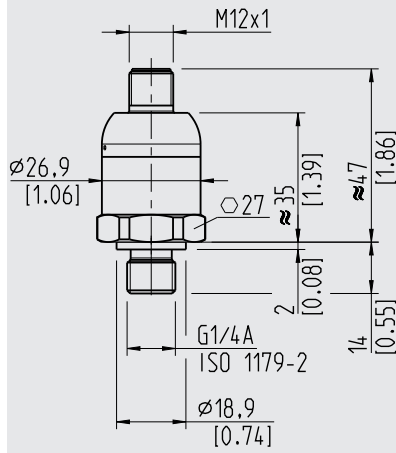

Weight: 80 ... 120 g [2.82 ... 4.23 oz]

Angular connector DIN 175301-803 A with LED status display

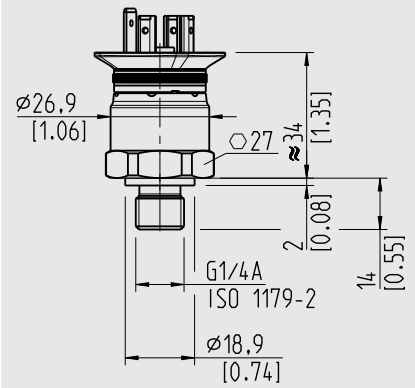

Weight: 60 ... 100 g [2.12 ... 3.53 oz]

**DIN EN ISO 1179-2
(formerly DIN 3852-E)**

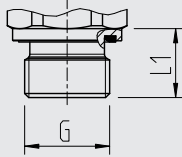

G	L1
G ¼ A	14 [0.55]
G ½ A	17 [0.67]

EN 837

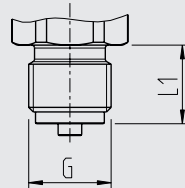

G	L1
G ¼ B	13 [0.51]
G ½ B	20 [0.79]

**ANSI/ASME B1.20.1
KS
ISO 7**

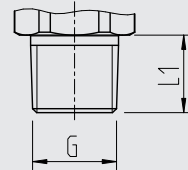

G	L1
¼ NPT	13 [0.51]
½ NPT	19 [0.75]
R ¼	13 [0.51]
PT ¼	13 [0.51]

Female thread

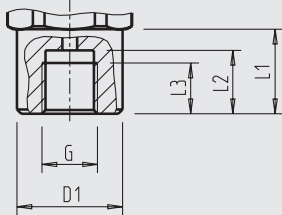

G	L1	L2	L3	D1
G ¼	20 [0.79]	15 [0.59]	12 [0.47]	∅ 25 [0.98]

EN 837, female thread

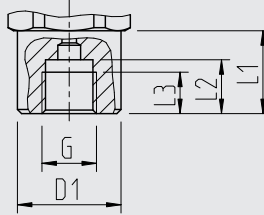





G	L1	L2	L3	D1
G ¼ A	20 [0.79]	13 [0.51]	10 [0.39]	∅ 25 [0.98]

Ermeto compatible





Accessories and spare parts

Sealings		
	Description	Order number
	NBR profile sealing G ¼ A DIN EN ISO 1179-2 (formerly DIN 3852-E)	1537857
	FPM/FKM profile sealing G ¼ A DIN EN ISO 1179-2 (formerly DIN 3852-E)	1576534
	NBR profile sealing G ½ A DIN EN ISO 1179-2 (formerly DIN 3852-E)	1039067
	FPM/FKM profile sealing G ½ A DIN EN ISO 1179-2 (formerly DIN 3852-E)	1039075
	Copper G ¼ B EN 837	11250810
	Stainless steel G ¼ B EN 837	11250844
	Copper G ½ B EN 837	11250861
	Stainless steel G ½ B EN 837	11251042

Connectors with moulded cable				
	Description	Temperature range	Cable diameter	Order number
	Straight version, cut to length, 4-pin, 2 m [6.6 ft] PUR cable, UL listed, IP67	-20 ... +80 °C [-4 ... +176 °F]	4.5 mm [0.18 in]	14086880
	Straight version, cut to length, 4-pin, 5 m [16.4 ft] PUR cable, UL listed, IP67	-20 ... +80 °C [-4 ... +176 °F]	4.5 mm [0.18 in]	14086883
	Straight version, cut to length, 4-pin, 10 m [32.8 ft] PUR cable, UL listed, IP67	-20 ... +80 °C [-4 ... +176 °F]	4.5 mm [0.18 in]	14086884
	Angled version, cut to length, 4-pin, 2 m [6.6 ft] PUR cable, UL listed, IP67	-20 ... +80 °C [-4 ... +176 °F]	4.5 mm [0.18 in]	14086889
	Angled version, cut to length, 4-pin, 5 m [16.4 ft] PUR cable, UL listed, IP67	-20 ... +80 °C [-4 ... +176 °F]	4.5 mm [0.18 in]	14086891
	Angled version, cut to length, 4-pin, 10 m [32.8 ft] PUR cable, UL listed, IP67	-20 ... +80 °C [-4 ... +176 °F]	4.5 mm [0.18 in]	14086892
	Connection cable, 4-pin, 2 m [6.6 ft] PUR cable, UL listed, IP67 1x LED green, 2x LED yellow	-20 ... +80 °C [-4 ... +176 °F]	4.5 mm [0.18 in]	14252834
	Connection cable, 4-pin, 5 m [16.4 ft] PUR cable, UL listed, IP67 1x LED green, 2x LED yellow	-20 ... +80 °C [-4 ... +176 °F]	4.5 mm [0.18 in]	14252835

IO-Link master		
	Description	Order number
	<p>IO-Link master</p> <ul style="list-style-type: none"> ■ USB port for setting, monitoring and diagnosing IO-Link instruments on notebook or desktop PC. ■ Connection of the IO-Link instruments via M12 x 1 circular connector ■ Licence for PC software (system requirement: Windows 7 / 8.1 and Windows 10 (32 or 64 bit) ■ Suitable for IO-Link version V1.0 and V1.1 ■ 115/230 V AC - 24 V DC (1 A) external power supply and international adapter included ■ Instruments with a current requirement of up to 80 mA can be operated without external power, otherwise, the DC 24 V (1 A) external power supply must be connected. 	14239506

Approvals

Logo	Description	Country
	EU declaration of conformity <ul style="list-style-type: none"> ■ EMC directive, EN 61326 emission (group 1, class B) and immunity (industrial application) ■ Pressure equipment directive ■ RoHS directive 	European Union
	UL Safety (e.g. electr. safety, overpressure, ...)	USA and Canada
	EAC EMC directive	Eurasian Economic Community
	GOST Metrology, measurement technology	Russia

Manufacturer's information and certificates

Logo	Description
-	China RoHS directive
-	MTTF > 100 years

Patents, property rights

Protected design (DPMA (German patent and trade mark office) no. 402017001481-0003)

Approvals and certificates, see website

Ordering information

Model / Accuracy / Measuring range / Process connection / Sealing / Medium temperature / Output signal / Electrical connection / Options for special media and overload safety

© 04/2019 WIKA Alexander Wiegand SE & Co. KG, all rights reserved.
 The specifications given in this document represent the state of engineering at the time of publishing.
 We reserve the right to make modifications to the specifications and materials.

