

Measuring insert For resistance thermometer, tubular design Model TR11-A

WIKA data sheet TE 60.13



for further approvals
see page 2

Applications

- Replacement measuring insert for servicing
- For all industrial and laboratory applications

Special features

- Application ranges from -50 ... +250 °C [-58 ... +482 °F]
- Tubular design
- Spring-loaded design
- Explosion-protected versions are available for many approval types (see page 2)



Measuring insert for resistance thermometer, model TR11-A

Description

The measuring inserts per DIN 43735 for resistance thermometers described here are designed for mounting in a protective fitting. Operation without thermowell is only recommended in certain applications. The measuring insert has been manufactured from a pipe closed on one side. The sensor is located in the tip of the measuring insert. The measuring inserts are delivered with pressure springs to ensure that the measuring inserts are pressed down to the thermowell bottom.

Apart from the DIN versions, customer-specific versions are available, for example:

- other measuring insert lengths (also intermediate lengths)
- without terminal block
- with transmitter

Type and number of sensors, accuracy and connection method can each be selected to suit the respective application.

A large number of different explosion-protected approvals are available for the TR11-A.

The range of applications is completed by designs without terminal block for direct transmitter installation. Optionally, analogue or digital transmitters from the WIKA range can be installed.

Explosion protection (option)









The permissible power P_{max} as well as the permissible ambient temperature for the respective category can be seen on the Ex certificate or in the operating instructions.





Attention:

Depending on the version, the measuring insert can be used in different ignition protection types when built into a model TR11-C resistance thermometer. With the correspondingly suitable protective fitting, operation in dust Ex hazardous areas is possible.

The use of a model TR11-A measuring insert is not permitted in hazardous areas without a suitable protective fitting.

Approvals (explosion protection, further approvals)

Logo	Description	Country
 	EU declaration of conformity <ul style="list-style-type: none"> ■ EMC directive ¹⁾ EN 61326 emission (group 1, class B) and interference immunity (industrial application) ■ RoHS directive ■ ATEX directive (option) Hazardous areas <ul style="list-style-type: none"> - Ex i Zone 0 gas II 1G Ex ia IIC T1 ... T6 Ga Zone 1 gas II 2G Ex ia IIC T1 ... T6 Gb - Ex e ²⁾ Zone 1 gas II 2G Ex eb IIC T1 ... T6 Gb ⁴⁾ Zone 2 gas II 3G Ex ec IIC T1 ... T6 Gc X - Ex n ²⁾ Zone 2 gas II 3G Ex nA IIC T1 ... T6 Gc X 	European Union
	IECEx (option) - in conjunction with ATEX Hazardous areas <ul style="list-style-type: none"> - Ex i Zone 0 gas Ex ia IIC T1 ... T6 Ga Zone 1 gas Ex ia IIC T1 ... T6 Gb - Ex e ³⁾ Zone 1 gas Ex eb IIC T1 ... T6 Gb ⁴⁾ Zone 2 gas Ex ec IIC T1 ... T6 Gc - Ex n ³⁾ Zone 2 gas Ex nA IIC T1 ... T6 Gc 	International
	EAC (option) Hazardous areas <ul style="list-style-type: none"> - Ex i Zone 0 gas 0Ex ia IIC T6 ... T1 Ga X - Ex n Zone 2 gas 2Ex nA IIC T6 ... T1 Gc X 	Eurasian Economic Community
	Ex Ukraine (option) Hazardous areas <ul style="list-style-type: none"> - Ex i Zone 0 gas II 1G Ex ia IIC T1...T6 Ga 	Ukraine
	INMETRO (option) Hazardous areas <ul style="list-style-type: none"> - Ex i Zone 0 gas Ex ia IIC T3 ... T6 Ga 	Brazil
	CCC (option) ⁴⁾ Hazardous areas <ul style="list-style-type: none"> - Ex i Zone 0 gas Ex ia IIC T1 ~ T6 Ga - Ex e ³⁾ Zone 2 gas Ex e IIC T1 ~ T6 Gb ⁴⁾ - Ex n ³⁾ Zone 2 gas Ex nA IIC T1 ~ T6 Gc 	China
	KCs - KOSHA (option) Hazardous areas <ul style="list-style-type: none"> - Ex i Zone 0 gas Ex ia IIC T4 ... T6 Zone 1 gas Ex ib IIC T4 ... T6 	South Korea
-	PESO (option) Hazardous areas <ul style="list-style-type: none"> - Ex i Zone 0 gas Ex ia IIC T1 ... T6 Ga Zone 1 gas Ex ia IIC T1 ... T6 Gb 	India

Logo	Description	Country
	GOST (option) Metrology, measurement technology	Russia
	KazInMetr (option) Metrology, measurement technology	Kazakhstan
-	MTSCHS (option) Permission for commissioning	Kazakhstan
	BelGIM (option) Metrology, measurement technology	Belarus
	UkrSEPRO (option) Metrology, measurement technology	Ukraine
	Uzstandard (option) Metrology, measurement technology	Uzbekistan

1) Only for built-in transmitter

2) Only in combination with connection head model BSZ, BSZ-H, 1/4000, 5/6000 or 7/8000

3) Only in combination with connection head model 1/4000, 5/6000 or 7/8000

4) Without transmitter

Instruments marked with "ia" may also be used in areas only requiring instruments marked with "ib" or "ic".

If an instrument with "ia" marking has been used in an area with requirements in accordance with "ib" or "ic", it can no longer be operated in areas with requirements in accordance with "ia" afterwards.

Approvals and certificates, see website

Sensor

Measuring element

Pt100 (measuring current: 0.1 ... 1.0 mA) ¹⁾

Connection method	
Single elements	1 x 2-wire 1 x 3-wire 1 x 4-wire 1 x 3-wire (face-sensitive sensor) 1 x 4-wire (face-sensitive sensor)
Dual elements	2 x 2-wire 2 x 3-wire 2 x 4-wire ²⁾

Validity limits of class accuracy per EN 60751	
Class	Thin-film
Class B	-50 ... +250 °C
Class A ³⁾	-30 ... +250 °C
Class AA ^{3) 4)}	0 ... +150 °C

1) For detailed specifications for Pt100 sensors, see Technical information IN 00.17 at www.wika.com.

2) Not with 3 mm diameter

3) Not with 2-wire connection method

4) Not with face-sensitive sensor

Electrical connection

(Colour code per EN/IEC 60751)

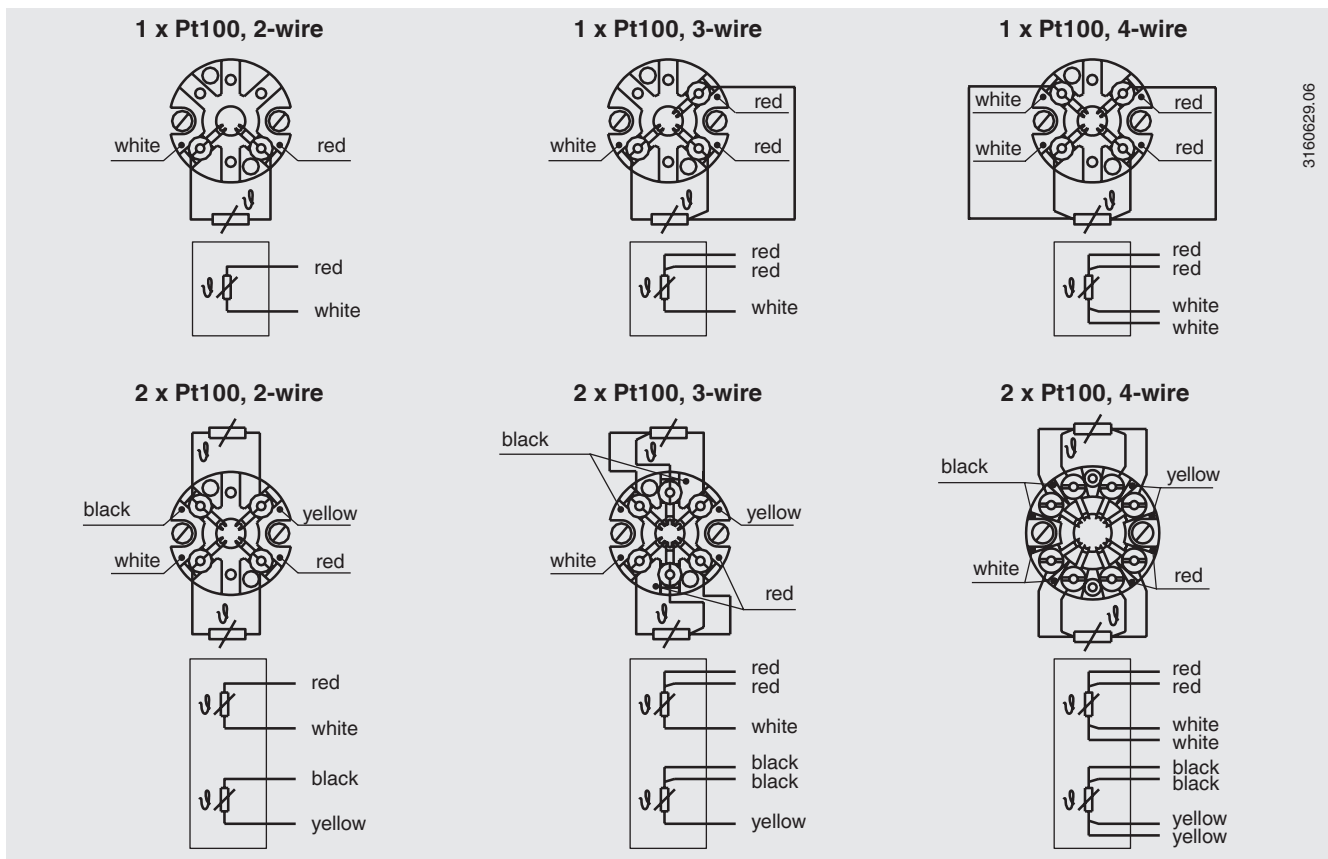

For the electrical connections of built-in temperature transmitters see the corresponding data sheets or operating instructions.

Transmitter (option)

A transmitter can be built upon the measuring insert. In this case, the transmitter replaces the terminal block and is directly attached to the terminal plate of the measuring insert. The temperature transmitter should be protected from temperatures over 85 °C.



Output signal 4 ... 20 mA, HART® protocol		
Transmitter (selectable versions)	Model T15	Model T32
Data sheet	TE 15.01	TE 32.04
Output		
4 ... 20 mA	x	x
HART® protocol	-	x
Connection method		
1 x 2-wire, 3-wire or 4-wire	x	x
Measuring current	< 0.2 mA	< 0.3 mA

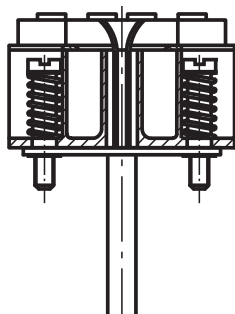

Measuring insert with mounted transmitter
(here: model T32)

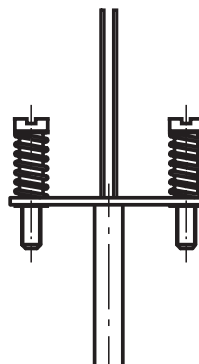

Measuring insert prepared for transmitter mounting

Dimensions in mm

The replaceable measuring insert is made of pipe closed on one side. The terminal blocks are generally built with recessed soldering lugs.

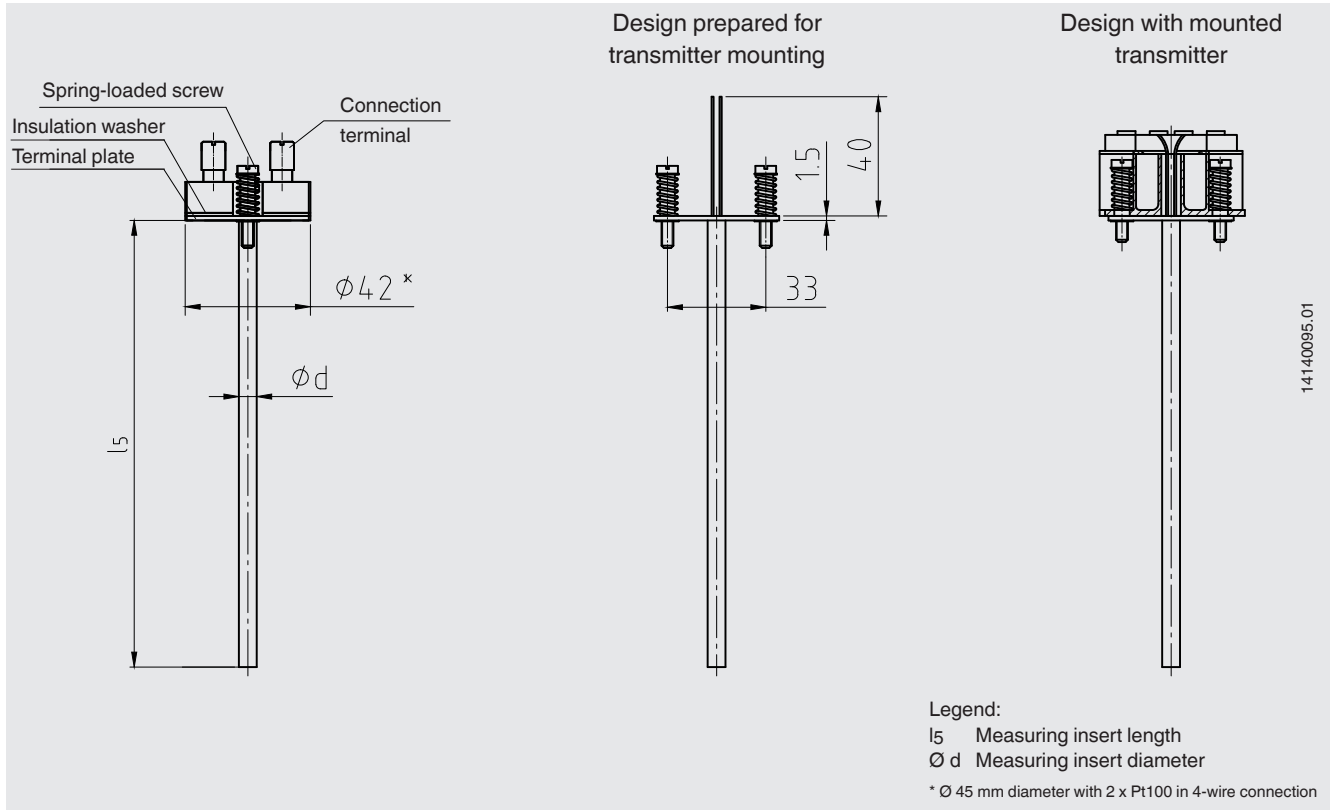

Measuring insert length l_5 in mm		Tolerance in mm
$\phi 6, \phi 8$	$\phi 3$	
75 ... 500	75 ... 250	+2 0

Measuring insert diameter ϕd in mm	Index per DIN 43735	Tolerance in mm
3 1)	31	3 ± 0.1
6	61	6 ± 0.1
8	81	8 ± 0.1

1) Not possible with 2 x Pt100, 4-wire

Only correct measuring insert length and correct measuring insert diameter ensure sufficient heat transfer from thermowell to the measuring insert.

The bore diameter of the thermowell should be a max. 1 mm larger than the measuring insert diameter.

Gaps of more than 0.5 mm between thermowell and the measuring insert will have a negative effect on the heat transfer, and they will result in unfavourable response behaviour of the thermometer.

When fitting the measuring insert into a thermowell, it is very important to determine the correct insertion length (= thermowell length for bottom thicknesses of ≤ 5.5 mm). In order to ensure that the measuring insert is firmly pressed down onto the bottom of the thermowell, the insert must be spring-loaded (spring travel: max 10 mm).

Materials

Material	
Tube material	Stainless steel 1.4571
	Stainless steel 316L

Certificates (option)

Certification type	Measurement accuracy	Material certificate
2.2 test report	x	x
3.1 inspection certificate	x	x
DKD/DAkkS calibration certificate	x	-

The different certifications can be combined with each other.

The minimum length for carrying out a measurement accuracy test 3.1 or DKD/DAkkS is 100 mm. Calibration of shorter lengths on request.

Operating conditions

Mechanical requirements

Version (per EN 60751)	
Standard	6 g peak-to-peak

The information on the vibration resistance refers to the tip of the measuring insert.

For detailed specifications for vibration resistance of Pt100 sensors, see Technical information IN 00.17 at www.wika.com.

Ambient and storage temperature

-40 ... +80 °C

Ingress protection

IP00 per EN/IEC 60529

The measuring inserts for the model TR11-A are designed for mounting into protective components (connection head + protection tube/thermowell).

These protective components feature connection heads/ cable glands/thermowells/protection tubes which ensure a higher IP protection.

Ordering information

Model / Explosion protection / Ignition protection type / Zone / Sensor / Class accuracy / Application range of the thermometer / Measuring insert length l_5 / Measuring insert diameter $\varnothing d$ / Pipe material / Certificates / Options

© 10/2015 WIKA Alexander Wiegand SE & Co. KG, all rights reserved.
The specifications given in this document represent the state of engineering at the time of publishing.
We reserve the right to make modifications to the specifications and materials.

