

Digital temperature transmitter

For thermocouples, head- and rail-mounted version

Models T16.H, T16.R

WIKA data sheet TE 16.01



for further approvals
see page 10

Applications

- Process industry
- Machine building and plant construction

Special features

- For the connection of all standard thermocouples
- High accuracy
- Parameterisation with the WIKAsoft-TT configuration software and electrical connection via quick connector magWIK
- Connection terminals also accessible from the outside
- EMC stability in compliance with the latest standard (EN 61326-2-3:2013)



Fig. left: Head mounting version, model T16.H

Fig. right: Rail mounting version, model T16.R

Description

These temperature transmitters are designed for universal use in plant and machine building, and also in the process industry. They offer high accuracy and excellent protection against electromagnetic influences (EMI). Via the WIKAsoft-TT configuration software and the model PU-548 programming unit, the model T16 temperature transmitters can be parameterised very easily, quickly and with a clear overview.

Besides the selection of the sensor type and the measuring range, the software enables the error signalling operation, damping, several measuring point descriptions and process adjustment to be stored. Furthermore, the WIKAsoft-TT software offers a line recording functionality where the temperature profile for the thermocouple connected to the T16 can be displayed.

The model T16 transmitter features diverse supervisory functionality, such as sensor-break detection and monitoring of the measuring range. Moreover, these transmitters have comprehensive cyclic self-monitoring functionality.

Specifications

Power supply	
Power supply U_B	DC 10 ... 35 V
Load R_A	$R_A \leq (U_B - 10 \text{ V}) / 0.0215 \text{ A}$ with R_A in Ω and U_B in V
Ex-relevant connection values	see "Safety-relevant characteristics (explosion-protected version)"
Insulation resistance (test voltage, input to analogue output)	AC 1,500 V

Load diagram

The permissible load depends on the loop supply voltage.

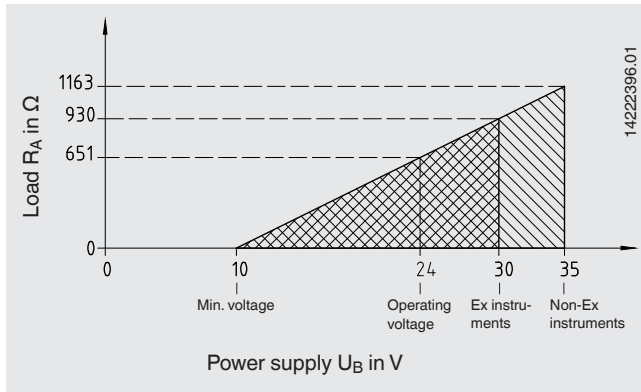

Designation of connection terminals

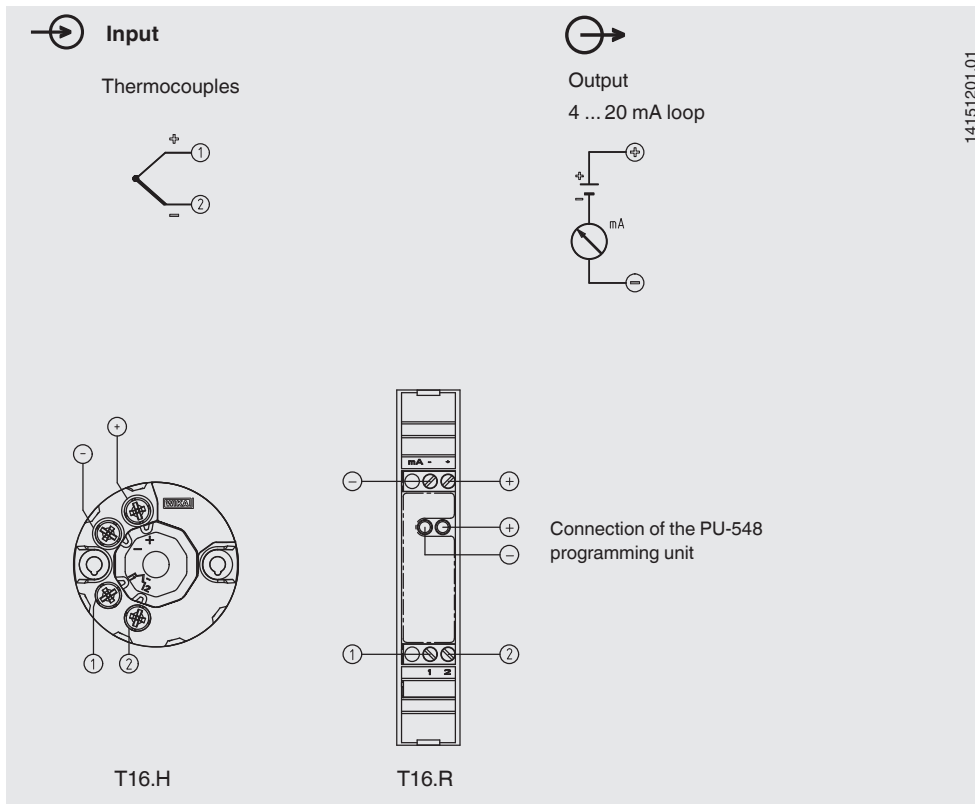

Input of the temperature transmitter			
Thermocouple type	Max. configurable measuring range (MR)	Standard	Min. measuring span (MS)
J	-210 ... +1,200 °C (-346 ... +2,192 °F)	IEC 60584-1	50 K
K	-270 ... +1,300 °C (-454 ... +2,372 °F)	IEC 60584-1	50 K
B	0 ... 1,820 °C (32 ... 3,308 °F)	IEC 60584-1	200 K
N	-270 ... +1,300 °C (-454 ... +2,372 °F)	IEC 60584-1	50 K
R	-50 ... +1,768 °C (-58 ... +3,214.4 °F)	IEC 60584-1	150 K
S	-50 ... +1,768 °C (-58 ... +3,214.4 °F)	IEC 60584-1	150 K
T	-270 ... +400 °C (-454 ... +752 °F)	IEC 60584-1	50 K
E	-270 ... +1,000 °C (-454 ... +1,832 °F)	IEC 60584-1	50 K
C	0 ... 2,315 °C (32 ... 4,199 °F)	IEC 60584-1	150 K
A	0 ... 2,500 °C (32 ... 4,532 °F)	IEC 60584-1	150 K
L (DIN 43710)	-200 ... +900 °C (-328 ... +1,652 °F)	DIN 43710	50 K
L (GOST R 8.585 - 2001)	-200 ... +800 °C (-328 ... +1,472 °F)	-	50 K

Factory configuration	
Sensor	Type K
Measuring range	0 ... 600 °C (32 ... +1.112 °F)
Error signalling	Downscale
Damping	Off

Analogue output, output limits, signalling		
Analogue output, configurable	Linear to temperature per IEC 60584/DIN 43710	
Output limits per NAMUR NE43	Lower limit 3.8 mA	Upper limit 20.5 mA
Current value for signalling, configurable per NAMUR NE43	Downscale < 3.6 mA (3.5 mA)	Upscale > 21.0 mA (21.5 mA)

Time response	
Switch-on time (time to get the first measured value)	Max. 4 s
Warm-up time	After a max. 45 minutes the accuracy specifications are reached (due to the internal cold junction)
Step response time	< 0.9 s (typical < 0.7 s)
Damping	Configurable between 1 s and 60 s
Typical measuring rate	Measured value update approx. 8/s

Accuracy specifications

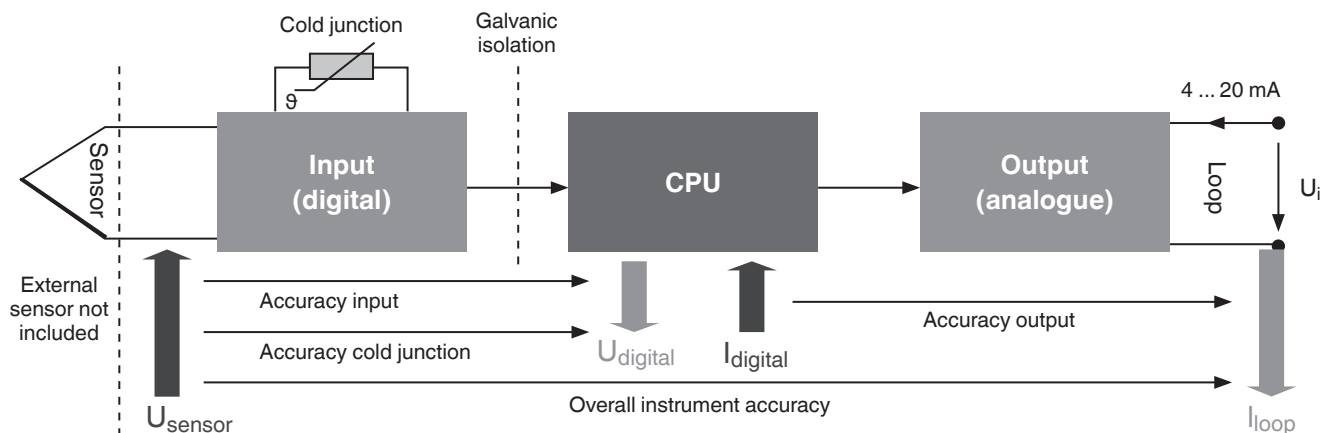

The product-specific accuracy specifications refer to the overall instrument.

$$(\text{Error}_{\text{overall}} = \text{Error}_{\text{input}} + \text{Error}_{\text{cold junction}} + \text{Error}_{\text{output}})$$

To determine the overall error, all possible types of error must be considered. These are summarised in the following table.

Special features			
Reference conditions	Calibration temperature $T_{\text{ref}} = 23 \text{ °C} \pm 3 \text{ K}$ (73.4 °F $\pm 5.4 \text{ °F}$) Power supply $U_{i,\text{ref}} = 24 \text{ V}$ Atmospheric pressure = 860 ... 1,060 hPa All accuracy specifications refer to the reference conditions.		
Accuracy specifications / validity	Input measuring deviation per DIN EN 60770, NE145 ¹⁾	Mean temperature coefficient (TC) every 10 K ambient temperature deviation from T_{ref}	Long-term drift in line with IEC 61298-2 per year
J / -150 ... +1,200 °C (-238 ... +2,192 °F)	$\leq 0 \text{ °C}$: 0.45 K + 0.3 % IMVI $\geq 0 \text{ °C}$: 0.45 K + 0.045 % MV	$\pm 1.7 \text{ K}$	40 μV / 0.1 % MV (greater value applies)
K / -150 ... +1,300 °C (-238 ... +2,372 °F)	$\leq 0 \text{ °C}$: 0.6 K + 0.3 % IMVI $\geq 0 \text{ °C}$: 0.6 K + 0.06 % MV		
B / 450 ... 1,820 °C (842 ... 3,308 °F)	$\leq 1,000 \text{ °C}$: 2.5 K + 0.3 % IMV - 1,000 $\geq 1,000 \text{ °C}$: 2.5 K		
N / -150 ... +1,300 °C (-238 ... +2,372 °F)	$\leq 0 \text{ °C}$: 0.75 K + 0.3 % IMVI $\geq 0 \text{ °C}$: 0.75 K + 0.045 % MV		
R / 50 ... 1,600 °C (122 ... 2,912 °F)	$\leq 400 \text{ °C}$: 2.2 K + 0.18 % IMVI $\geq 400 \text{ °C}$: 2.2 K + 0.015 % MV		
S / 50 ... 1,600 °C (122 ... 2,912 °F)	$\leq 400 \text{ °C}$: 2.2 K + 0.18 % IMVI $\geq 400 \text{ °C}$: 2.2 K + 0.015 % MV		
T / -150 ... +400 °C (-238 ... +752 °F)	$\leq 0 \text{ °C}$: 0.6 K + 0.3 % IMVI $\geq 0 \text{ °C}$: 0.6 K + 0.015 % MV		
E / -150 ... +1,000 °C (-238 ... +1,832 °F)	$\leq 0 \text{ °C}$: 0.45 K + 0.3 % IMVI $\geq 0 \text{ °C}$: 0.45 K + 0.045 % MV		
C / 0 ... 2,315 °C (32 ... 4,199 °F)	$\leq 1,000 \text{ °C}$: 2.2 K + 0 % IMVI $\geq 1,000 \text{ °C}$: 2.2 K + 0.175 % MV - 1,000		
A / 0 ... 2,315 °C (32 ... 4,199 °F)	$\leq 1,000 \text{ °C}$: 2.4 K + 0 % IMVI $\geq 1,000 \text{ °C}$: 2.4 K + 0.175 % MW - 1,000		
L (DIN 43710) / -150 ... +900 °C (-238 ... +1,652 °F)	$\leq 0 \text{ °C}$: 0.45 K + 0.15 % IMVI $\geq 0 \text{ °C}$: 0.45 K + 0.045 % MV		
L (GOST R 8.585 - 2001) / -150 ... +900 °C (-238 ... +1,652 °F)	$\leq 0 \text{ °C}$: 0.45 K + 0.15 % IMVI $\geq 0 \text{ °C}$: 0.45 K + 0.045 % MV		
Cold junction	$\leq \pm 1.5 \text{ K}$ ($\leq \pm 2.7 \text{ °F}$)		
Output measuring deviation (DA converter)	0.045 % of the MS	0.06 % of the MS	0.1 % of the MS
Influence of power supply every 1 V voltage change from $U_{i,\text{ref}}$	$\pm 0.005 \text{ % of the MS}$		

MV = measured value MS = measuring span

1) In the event of interference caused by high-frequency electromagnetic fields in a frequency range from 80 to 400 MHz, an increased measuring deviation of up to 0.8 % is expected. During transient interferences (e.g. burst, surge, ESD) take into account an increased measuring deviation of up to 1.5 %.

Transmitter accuracy examples

Example 1

Thermocouple type K Measuring range 0 ... 400 °C → span 400 K (720 °F) Ambient temperature 25 °C (77 °F) Measured value 300 °C (572 °F)	
Input 300 °C > 0 °C → 0.6 K + 0.06 % x MV 0.6 K + (0.06 % x 300 °C)	±0.78 K (±1.4 °F)
Output 0.045 % x 300 K	±0.135 K (±0.243 °F)
Cold junction 1.5 K	±1.5 K (±2.7 °F)
Measuring deviation (typical) $\sqrt{\text{input}^2 + \text{output}^2 + \text{cold junction}^2}$	±1.7 K (±3.06 °F)
Measuring deviation (maximum) Input + TC _{input} + output + cold junction	±2.42 K (±4.36 °F)

Example 2

Thermocouple type K Measuring range 0 ... 600 °C → span 600 K (1.080 °F) Ambient temperature 45 °C (113 °F) Measured value 550 °C (1.022 °F)	
Input 550 °C > 0 °C → 0.6 K + 0.06 % x MV 0.6 K + (0.06 % x 550 °C)	±0.93 K (±1.67 °F)
Input temperature coefficient 45 °C - 26 °C = 19 K → 2 x 10 K	±0.4 K (±0.72 °F)
Output 0.045 % x 600 K	±0.27 K (±0.49 °F)
Output temperature coefficient 45 °C - 26 °C = 19 K → 2 x 10 K 0.06 % x 600 K x 2	±0.72 K (±1.3 °F)
Cold junction 1.5 K	±1.5 K (±2.7 °F)
Cold junction temperature coefficient 45 °C - 26 °C = 19 K → 2 x 10 K	±4.0 K (±7.2 °F)
Measuring deviation (typical) $\frac{\sqrt{\text{input}^2 + \text{TC}_{\text{input}}^2 + \text{output}^2 + \text{TC}_{\text{output}}^2 + \text{cold junction}^2 + \text{TC}_{\text{cold junction}}^2}}{\text{cold junction}^2 + \text{TC}_{\text{cold junction}}^2}$	±4.5 K (±8.1 °F)
Measuring deviation (maximum) Input + TC _{input} + output + cold junction	±7.8 K (±14.04 °F)

Monitoring	
Sensor-break monitoring	Configurable via software Default: Downscale
Measuring range monitoring	Monitoring of the set measuring range for upper/lower deviations configurable Default: Deactivated
Drag pointer (internal temperature of the electronics)	Stores the maximum ambient temperature (no reset possible)

Case	T16.H head mounting version	T16.R rail mounting version
Material	Plastic PBT, glass-fibre reinforced	Plastic
Weight	approx. 50 g (approx. 1.76 oz)	approx. 0.2 kg (approx. 7.1 oz)
Ingress protection	IP00 (Electronics completely potted)	IP20
Connection terminals, captive screws, wire cross-section ■ Solid wire ■ Stranded wire with end splice	0.14 ... 2.5 mm ² (24 ... 14 AWG) 0.14 ... 1.5 mm ² (24 ... 16 AWG)	0.14 ... 2.5 mm ² (24 ... 14 AWG) 0.14 ... 2.5 mm ² (24 ... 14 AWG)
Recommended screwdriver to use	Cross head ('Pozidrive' tip), size 2 (ISO 8764)	Slotted, 3 x 0.5 mm (ISO 2380)
Recommended tightening torque	0.5 Nm	0.5 Nm

Ambient conditions	
Permissible ambient temperature range	{-50} -40 ... +85 {+105} °C {-58} -40 ... +185 {+221} °F
Climate class per IEC 654-1:1993	Cx (-40 ... +85 °C / -40 ... +185 °F, 5 ... 95 % r. h.)
Maximum permissible humidity ■ Model T16.H per IEC 60068-2-38:2009 ■ Model T16.R per IEC 60068-2-30:2005	Test max. temperature variation 65 °C (149 °F) / -10 °C (14 °F), 93 % ±3 % r. h. Test max. temperature 55 °C (131 °F), 95 % r. h.
Vibration resistance per IEC 60068-2-6:2008	Test Fc: 10 ... 2,000 Hz; 10 g, amplitude 0.75 mm (0,03 in)
Shock resistance per IEC 68-2-27:2009	Acceleration / Shock width Model T16.H: 100 g / 6 ms Model T16.R: 30 g / 11 ms
Salt fog per IEC 68-2-52:1996, IEC 60068-2-52:1996	Severity level 1
Condensation	Model T16.H: Acceptable Model T16.R: Acceptable in vertical mounting position
Free fall in line with IEC 60721-3-2:1997, DIN EN 60721-3-2:1998	Drop height 1.5 m (4,9 ft)
Electromagnetic compatibility (EMC) per DIN EN 55011:2010, DIN EN 61326-2-3:2013, NAMUR NE21:2012, GL 2012 VI Part 7	Emission (group 1, class B) and interference immunity (industrial application) [HF field, HF cable, ESD, Burst, Surge]

{ } Items in curved brackets are options for an additional price, not for ATEX versions of the head mounting version and not for T16.R rail mounting version

Safety-relevant characteristics (explosion-protected version)

■ Models T16.x-AI, T16.x-AC

Intrinsically safe connection values for the current loop (4 ... 20 mA)

Protection level Ex ia IIC/IIB/IIA, Ex ia IIIC or Ex ic IIC/IIB/IIA

Parameters	Models T16.x-AI, T16.x-AC	Models T16.x-AI
	Gas hazardous application	Dust hazardous application
Terminals	+ / -	+ / -
Voltage U_i	DC 30 V	DC 30 V
Current I_i	130 mA	130 mA
Power P_i	800 mW	750/650/550 mW
Effective internal capacitance C_i	7.8 nF	7.8 nF
Effective internal inductance L_i	20 µH	20 µH

Sensor circuit

Parameters	Models T16.x-AI	Model T16.x-AC
	Ex ia IIC/IIB/IIA Ex ia IIIC	Ex ic IIC/IIB/IIA
Terminals	1 - 2	
Voltage U_o	DC 6.6 V	
Current I_o	4 mA	
Power P_o	10 mW	
Characteristic curve	Linear	

Due to distance requirements of the applied standards, the IS power and signal circuit as well as the IS sensor circuit shall be considered as being galvanically connected to each other.

Ambient temperature range

Application	Ambient temperature range	Temperature class	Power P _i
Group II	$-40\text{ °C } (-40\text{ °F}) \leq T_a \leq +85\text{ °C } (+185\text{ °F})$	T4	800 mW
	$-40\text{ °C } (-40\text{ °F}) \leq T_a \leq +70\text{ °C } (+158\text{ °F})$	T5	800 mW
	$-40\text{ °C } (-40\text{ °F}) \leq T_a \leq +55\text{ °C } (+131\text{ °F})$	T6	800 mW
Group IIIC	$-40\text{ °C } (-40\text{ °F}) \leq T_a \leq +40\text{ °C } (+104\text{ °F})$	N / A	750 mW
	$-40\text{ °C } (-40\text{ °F}) \leq T_a \leq +75\text{ °C } (+167\text{ °F})$	N / A	650 mW
	$-40\text{ °C } (-40\text{ °F}) \leq T_a \leq +85\text{ °C } (+185\text{ °F})$	N / A	550 mW

N / A = not applicable

Comments:

U_o: Maximum voltage of any conductor against the other three conductors

I_o: Maximum output current for the least favourable connection of the internal current limiting resistors

P_o: U_o x I_o divided by 4 (linear characteristic)

■ Models T16.x-AN, T16.x-AE

Power and signal circuit (4 ... 20 mA loop)

Protection level Ex nA IIC/IIB/IIA

Parameters	Models T16.x-AN, T16.x-AE
	Gas hazardous application
Terminals	+ / -
Voltage U _i	DC 35 V
Current I _i	21.5 mA

Sensor circuit

Protection level Ex nA IIC/IIB/IIA

Parameters	Models T16.x-AN, T16.x-AE
Terminals	1 - 2
Power P _o	2.575 V x 0.1 mA → 0.256 mW DC 2.575 V 0.1 mA

Ambient temperature range

Application	Ambient temperature range	Temperature class
Group II	$-40\text{ °C } (-40\text{ °F}) \leq T_a \leq +85\text{ °C } (+185\text{ °F})$	T4
	$-40\text{ °C } (-40\text{ °F}) \leq T_a \leq +70\text{ °C } (+158\text{ °F})$	T5
	$-40\text{ °C } (-40\text{ °F}) \leq T_a \leq +55\text{ °C } (+131\text{ °F})$	T6

Dimensions in mm

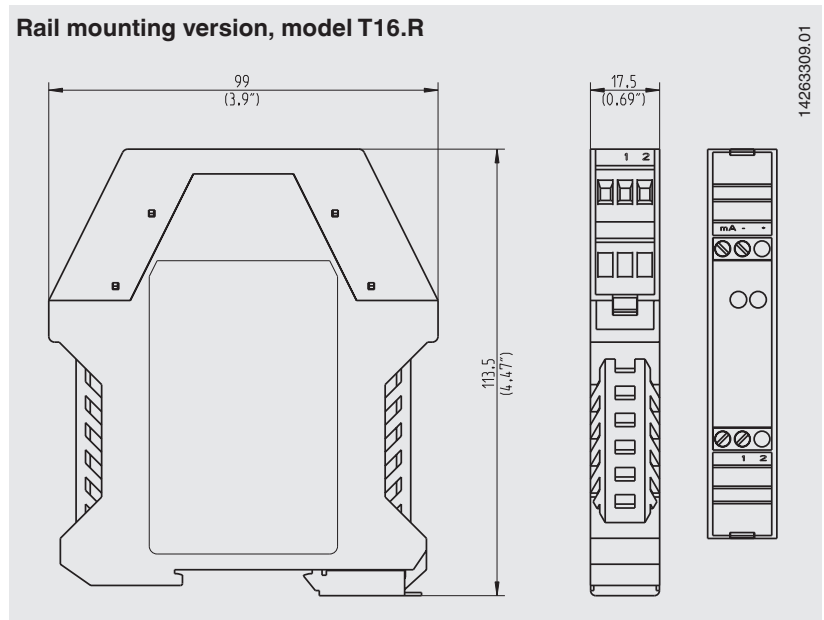
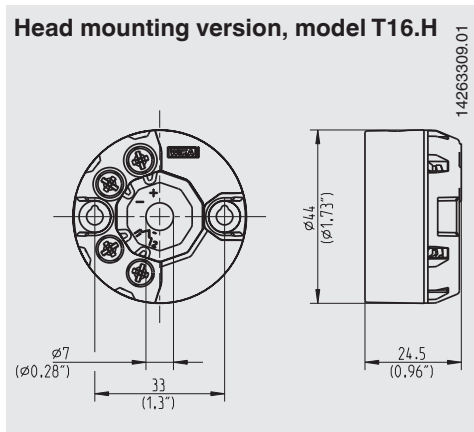

The dimensions of the head-mounted transmitter match the form B DIN connection heads with extended mounting space, e.g. WIKA model BSZ.

The transmitters in rail mounting cases are suitable for all standard rails in accordance with IEC 60715.

Connecting the PU-548 programming unit



Attention:



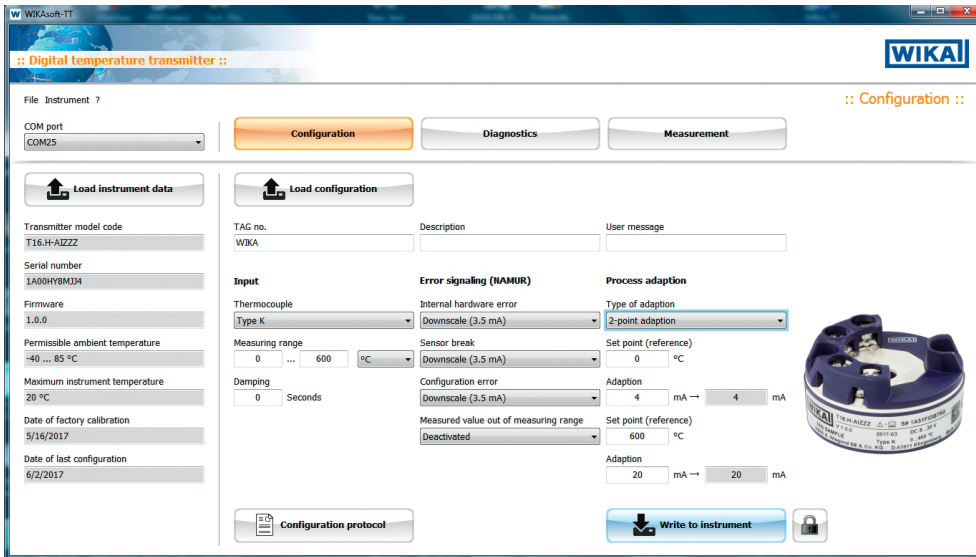

For direct communication via the USB interface of a PC/notebook, a model PU-548 programming unit is needed (see "Accessories").

Configuration software WIKAsoft-TT













Accessories

WIKA configuration software: free download from www.wika.com

Model	Version	Order number
Programming unit Model PU-548 	<ul style="list-style-type: none"> ■ Simple operation ■ LED status display ■ Compact design ■ No further voltage supply is needed for either the programming unit or for the transmitter ■ Incl. 1 model magWIK magnetic quick connector (replaces programming unit model PU-448)	14231581
Magnetic quick connector magWIK 	<ul style="list-style-type: none"> ■ Replacement for crocodile clips and HART® terminals ■ Fast, safe and tight electrical connection ■ For all configuration and calibration processes 	14026893
Adapter 	<ul style="list-style-type: none"> ■ Suitable for TS 35 per DIN EN 60715 (DIN EN 50022) or TS 32 per DIN EN 50035 ■ Material: Plastic / stainless steel ■ Dimensions: 60 x 20 x 41.6 mm (2.3 x 0.7 x 1.6 in) 	3593789
Adapter 	<ul style="list-style-type: none"> ■ Suitable for TS 35 per DIN EN 60715 (DIN EN 50022) ■ Material: Steel tin galvanized ■ Dimensions: 49 x 8 x 14 mm 	3619851

Approvals

Logo	Description	Country
 	EU declaration of conformity <ul style="list-style-type: none"> ■ EMC directive EN 61326 emission (group 1, class B) and interference immunity (industrial application) ■ RoHS directive ■ ATEX directive (option) Hazardous areas <ul style="list-style-type: none"> - Ex i Zone 0 gas [II 1G Ex ia IIC T6 ... T4 Ga] <li style="padding-left: 40px;">Zone 2 gas [II 3G Ex ic IIC T6 ... T4 Gc X] <li style="padding-left: 40px;">Zone 20 dust [II 1D Ex ia IIIC T135 °C Da] - Ex e Zone 2 gas [II 3G Ex ec IIC T6 ... T4 Gc X] - Ex n Zone 2 gas [II 3G Ex nA IIC T6 ... T4 Gc X] 	European Union
	IECEx (option) Hazardous areas <ul style="list-style-type: none"> - Ex i Zone 0 gas [Ex ia IIC T6 ... T4 Ga] <li style="padding-left: 20px;">Zone 2 gas [Ex ic IIC T6 ... T4 Gc X] <li style="padding-left: 20px;">Zone 20 dust [Ex ia IIIC T135 °C Da] - Ex e Zone 2 gas [Ex ec IIC T6 ... T4 Gc X] - Ex n Zone 2 gas [Ex nA IIC T6 ... T4 Gc X] 	International
	FM (option) Hazardous areas <ul style="list-style-type: none"> Class I, division 1 or 2, groups A/B/C/D, T6 ... T4 Class I, zone 0/1, AEx ia IIC T6 ... T4 	USA
	CSA (option) Hazardous areas <ul style="list-style-type: none"> Class I, division 1 or 2, groups A/B/C/D, T6 ... T4 Class II, division 1 or 2, groups E/F/G, T6 ... T4 / T135 °C, class III Class I, zone 0 or 1, Ex ia [ia Ga] IIC T6 ... T4 Ga Class I, zone 20 or 21, Ex ia [ia Da] IIIC T135 °C Da 	Canada
	EAC (option) <ul style="list-style-type: none"> ■ EMC directive ■ Hazardous areas <ul style="list-style-type: none"> - Ex i Zone 0 gas [0 Ex ia IIC T4/T5/T6] <li style="padding-left: 40px;">Zone 1 gas [1 Ex ib IIC T4/T5/T6] <li style="padding-left: 40px;">Zone 2 gas [2 Ex ic IIC T4/T5/T6] <li style="padding-left: 40px;">Zone 20 dust [DIP A20 Ta 135 °C] <li style="padding-left: 40px;">Zone 21 dust [DIP A21 Ta 135 °C] - Ex n Zone 2 gas [Ex nA IIC T4/T5/T6] - Ex e Zone 2 gas [2 Ex e IIC T4/T5/T6] 	Eurasian Economic Community
	GOST (option) Metrology, measurement technology	Russia
	KazInMetr (option) Metrology, measurement technology	Kazakhstan
	DNOP - MakNII (option) <ul style="list-style-type: none"> ■ Mining ■ Hazardous areas <ul style="list-style-type: none"> - Ex i Zone 0 gas [II 1G Ex ia IIC T6 ... T4 Ga] <li style="padding-left: 40px;">Zone 20 dust [II 1D Ex ia IIIC T135 °C Da] 	Ukraine
	Uzstandard (option) Metrology, measurement technology	Uzbekistan

Certificates (option)

- 2.2 test report
- 3.1 inspection certificate

Approvals and certificates, see website

Ordering information

Model / Explosion protection / Additional approvals / Permissible ambient temperature / Configuration / Certificates / Options

© 03/2017 WIKA Alexander Wiegand SE & Co. KG, all rights reserved.
The specifications given in this document represent the state of engineering at the time of publishing.
We reserve the right to make modifications to the specifications and materials.

